

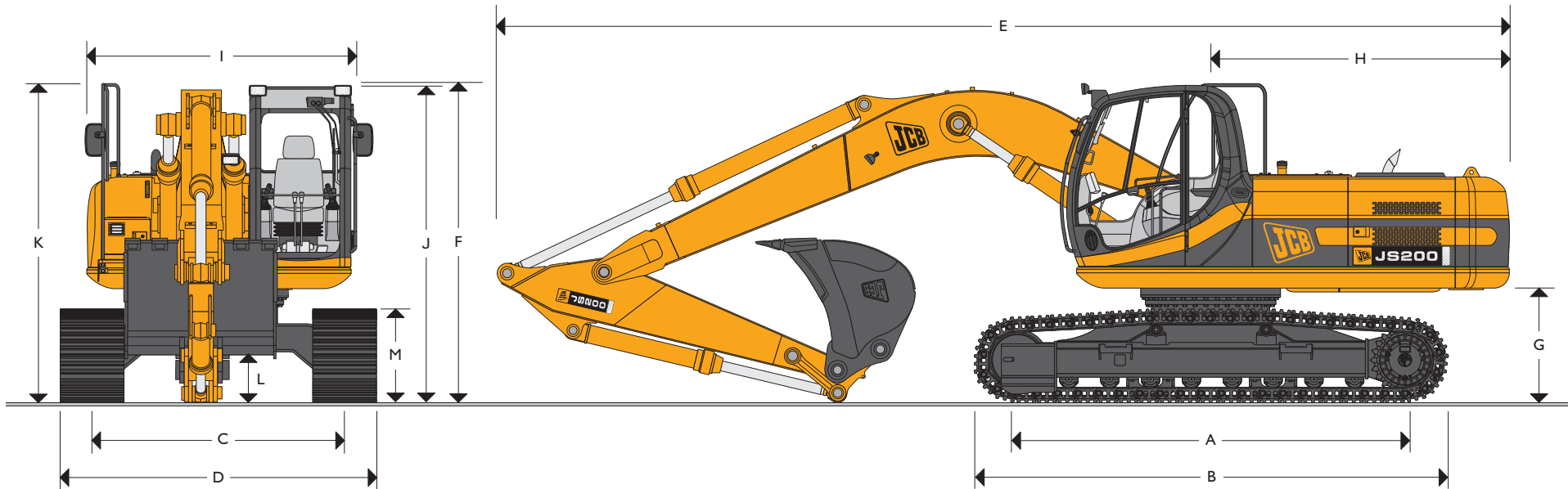

# JCB TRACKED EXCAVATOR | JS 200 NC/SC/LC



MAX. OPERATING WEIGHT 21190 kg  
 NETT ENGINE POWER 102 kW



## STATIC DIMENSIONS

Dimensions in millimetres (ft-in)	NC	SC	LC
<b>A</b> Track length on ground	3370 (11-1)	3370 (11-1)	3660 (12-0)
<b>B</b> Undercarriage overall length	4170 (13-8)	4170 (13-8)	4460 (14-8)
<b>C</b> Track gauge	1990 (6-6)	2200 (7-2)	2390 (7-10)
<b>D</b> Width over tracks (500mm trackshoes)	2490 (8-2)	2700 (8-10)	-
<b>D</b> Width over tracks (600mm trackshoes)	2590 (8-6)	2800 (9-2)	2990 (9-10)
<b>D</b> Width over tracks (700mm trackshoes)	2690 (8-10)	2900 (9-6)	3090 (10-2)
<b>D</b> Width over tracks (800mm trackshoes)	-	-	3190 (10-6)
<b>D</b> Width over tracks (900mm trackshoes)	-	-	3290 (10-10)

Dipper lengths	1.91m	2.40m	3.0m
<b>E</b> Transport length with Monoboomb	9570 (31-5)	9560 (31-4)	9440 (31-0)
<b>F</b> Transport height with Monoboomb	3055 (10-0)	3060 (10-0)	3025 (9-11)

Dimensions in millimetres (ft-in)	
<b>G</b> Counterweight clearance	1066 (3-6)
<b>H</b> Tailswing radius	2825 (9-3)
<b>I</b> Width of superstructure	2549 (8-4)
<b>J</b> Height over cab	2946 (9-8)
<b>K</b> Height over grab rail	3025 (9-11)
<b>L</b> Ground clearance	486 (1-7)
<b>M</b> Track height	885 (2-11)



# JCB TRACKED EXCAVATOR | JS 200 NC/SC/LC



## ENGINE

<b>Model</b>	Isuzu BB-6BGIT. European Tier II emissions compliant.
<b>Type</b>	Water cooled, 4-stroke, 6-cylinder in-line, direct injection, turbocharged diesel.
<b>Nett power (ISO 3046-INF)</b>	102kW (138hp) at 1950rpm.
<b>Piston Displacement</b>	6.494 litres (396 cu.in.).
<b>Injection</b>	Mechanical governor.
<b>Air Filtration</b>	Dry element with secondary safety element and in cab warning indicator.
<b>Cooling</b>	Water cooler via large capacity radiator.
<b>Starting system</b>	24 volt – 4.5kW.
<b>Batteries</b>	2 x 12 volt Heavy Duty.
<b>Alternator</b>	24 volt 40 amp.
<b>Refuelling pump</b>	Electric type.

## SWING SYSTEM

<b>Swing motor</b>	Axial piston.
<b>Swing brake</b>	Hydraulic braking plus automatic spring applied disc type parking brake.
<b>Final drive</b>	Planetary reduction.
<b>Swing speed</b>	12.9rpm.
<b>Swing gear</b>	Large diameter, internally toothed fully sealed grease bath lubricated.
<b>Swing lock</b>	Switchable brake in cab.

## UNDERCARRIAGE

<b>Carriage options</b>	SC-Standard, NC-Narrow and LC-Long Carriage.	
<b>Construction</b>	Fully welded, "X" frame type with central bellyguarding and track motor guards. Sloping sidemembers with dirt relief holes under top rollers.	
<b>Recovery point</b>	Front and rear.	
<b>Track type</b>	Sealed and greased.	
<b>Track shoe options</b>	NC & SC – 500mm (20in), 600mm (24in), 700mm (28in). LC – 600mm (24in), 700mm (28in), 800mm (31.5in), 900mm (36in).	
<b>Upper &amp; lower rollers</b>	Heat treated, sealed and lubricated.	
<b>Track adjustment</b>	Grease cylinder type.	
<b>Track idler</b>	Sealed and lubricated, with spring cushioned recoil.	
	<b>NC &amp; SC</b>	<b>LC</b>
<b>No. of track guides</b>	2 per side	2 per side
<b>No. of lower rollers</b>	7 per side	8 per side
<b>No. of upper rollers</b>	2 per side	2 per side
<b>No. of track shoes</b>	46 per side	49 per side

## HYDRAULICS

A variable flow load sensing system with flow on demand, variable power output and servo operated, multi-function open centre control. Machine auto warm up standard – maximises performance in cold conditions.

### Pumps

<b>Main pumps</b>	2 variable displacement axial piston type.
<b>Maximum flow</b>	2 x 214 L/min (2 x 47 UK GPM).
<b>Servo pump</b>	Gear type.
<b>Maximum flow</b>	20 L/min (4.4 UK GPM).

### Control valve

A combined four and five spool control valve with auxiliary service spool as standard. When required twin pump flow is combined to boom, dipper and bucket services for greater speed and efficiency.

### Relief valve settings

<b>Boom/Arm/Bucket</b>	343 bar (4975 lbf/sq.in)
<b>Automatic power boost</b>	373 bar (5410 lbf/sq.in)
<b>Swing circuit</b>	289 bar (4190 lbf/sq.in)
<b>Travel circuit</b>	343 bar (4975 lbf/sq.in)
<b>Pilot control</b>	40 bar (580 lbf/sq.in)

A separate Cushion Control valve in the servo system provides cushioning of the boom and dipper spools selection and quick warm-up of the servo system.

### Hydraulic cylinders

Double acting type, with bolt-up end caps and hardened steel bearing bushes. End cushioning is fitted as standard on boom, dipper and bucket rams.  
Optional hose burst check valves available for boom and dipper rams.

### Filtration

The hydraulic components are protected by the highest standard of filtration to ensure long hydraulic fluid and component life.

<b>In tank</b>	150 micron, suction strainer.
<b>Main return line</b>	10 micron, fibreform element.
<b>Plexus Bypass line</b>	1.5 micron, paper element.
<b>Pilot line</b>	10 micron, paper element.
<b>Hydraulic hammer return</b>	10 micron, reinforced microform element.

### Cooling

Cooling is provided via a full return line air blast cooler as part of a single face cooling pack in conjunction with the engine water cooler.

## TRACK DRIVE

<b>Type</b>	Fully hydrostatic, three speed with autoshift between high and medium speed.
<b>Travel motors</b>	Variable swash axial piston type, fully guarded within undercarriage frame.
<b>Final drive</b>	Planetary reduction, bolt-on sprockets.
<b>Service brake</b>	Hydraulic counter balance valve to prevent overspeeding on gradients.
<b>Park brake</b>	Disc type, spring applied, automatic hydraulic release.
<b>Gradeability</b>	70% (35 deg) continuous.
<b>Travel speed</b>	High – 5.6 km/h (3.4 mph). Mid – 3.3 km/h (2.1 mph). Low – 2.3 km/h (1.4 mph).
<b>Tractive effort</b>	191.9kN (19570 kgf, 43144 lbf).



# JCB TRACKED EXCAVATOR | JS 200 NC/SC/LC



## EXCAVATOR END

Monoboom available along with a choice of dipper lengths to suit the requirements of reach, dig-depth, loadover height, tearover and site versatility. Reserve strength is built into the fully welded structures for hydraulic hammer and other arduous operations. Fabricated bucket tipping links are provided with a choice of lift points.

Strong, durable construction, large cross sections and multi plate fabrications to withstand high stress applications. The 5.7m (18ft 8in) boom is designed to ensure the optimum digging envelope when matched with the three dipper lengths. Low maintenance bronze alloy bushes with graphite plugs are fitted to boom base and boom to dipper pivots resulting in 1000 hour greasing intervals at these points.

## CAB

Excellent digging, loading and positioning visibility results from the careful design of front, side and roof lights. All screens are tinted to improve in cab conditions.

Fully opening front screen is very smooth to operate and as the lower screen is stored within the top screen frame it makes complete front screen opening easy, fast and convenient.

Fresh air ventilation available from opening door window, opening slot in front screen and fully opening front screen. Parallelogram wash wiper for upper screen ensuring good wiped area for maximum visibility. Wiper motor is fitted in the left hand side of the roof screen so as not to affect bucket visibility when loading. Optional lower screen wiper available.

Fresh air ventilation and heater with windscreen demister. Infinitely variable blower speed, temperature and recirculation control. Air conditioning or climate control incorporating chilled cool box available as option. Fully adjustable deluxe suspension seat with arm rest adjustment and backrest recline. Radio cassette player with digital tuner fitted into the roof lining for maximum protection. Conveniently placed radio mute button incorporated into lower console. 12v power point and mobile phone holder built into the right hand console. Courtesy light can be operated from ground level and is illuminated for five minutes or until switched off improving operator access at night. Cab mounted roller blind protects operator from sun's glare through front or top screens.

## AMS – ADVANCED MANAGEMENT SYSTEM

Four selectable working modes link the operators control movements with the engine and hydraulic systems to maximise productivity and efficiency.

### A (Auto)

Up to 100% engine power and 100% flow. Gives variable power and speed depending on the operator's input, matching the demand for output and efficiency to the job. Power boost is automatically activated in this mode should hard conditions be encountered. Auto idle cuts in after a period of inactivity (between 5 and 30 seconds as set by the operator)

### E (Economy)

80% engine power. 95% of hydraulic flow maximises economy while maintaining excellent output.

### P (Precision)

55% engine power. 90% of hydraulic flow for fine control of grading operations.

### L (Lifting)

55% engine power. 63% of hydraulic flow with permanent power boost for maximum lifting power and control.

The Auto mode allows the AMS processor to select the optimum operational performance to match the demands of the job while the three alternative modes give precise matching of application when specific tasks are undertaken.

The adjustable position monitor mounted on the front right hand pillar of the cab gives the operator a constant read out of mode, tracking range, operating temperature and a host of other information, while retaining excellent visibility of the monitor and the job being carried out.

The required flow for hammer applications can be set and stored in the AMS memory and is automatically activated whenever the hammer pedal is depressed.

A maintenance indicator warns of imminent service needs, and all servicing and basic checks can be carried out using only the in cab display.

## CONTROLS

### Excavator

All servo lever operated to ISO control pattern, independently adjustable to the seat.

### Tracks

Individually servo operated by foot pedal or hand lever.

### Auxiliary

Speed selection via joystick button.

### Control isolation

Via servo operated foot pedal.

### Engine speed

Via gate lock lever at cab entrance or panel switch.

Dial type throttle control plus servo lever mounted one-touch idle control or separate selectable auto-idle with adjustable time delay using AMS.

### Engine stop

Ignition key operated and separate shut-down button.

### Horn

Operated via servo lever mounted button.



# JCB TRACKED EXCAVATOR | JS 200 NC/SC/LC



## SERVICE CAPACITIES

Fuel tank	litres (UK gal)	343 (75.5)
Engine coolant	litres (UK gal)	25.5 (5.61)
Engine oil	litres (UK gal)	21.5 (4.7)
Swing reduction gear	litres (UK gal)	5.0 (1.1)
Track reduction gear (each side)	litres (UK gal)	4.7 (1.0)
Hydraulic system	litres (UK gal)	200 (44)
Hydraulic tank	litres (UK gal)	120 (26.4)

## GENERAL PURPOSE EXCAVATOR BUCKETS

All buckets are JCB – Esco type fully welded steel, with sealed, hardened steel pivot pins and replaceable wear parts.

Max Width	Capacity (SAE heaped)	Weight
600mm (24in.)	0.40cu.m (0.52cu.yd)	484kg (1067lb)
900mm (36in.)	0.71cu.m (0.93cu.yd)	595kg (1312lb)
1000mm (39in.)	0.81cu.m (1.06cu.yd)	627kg (1382lb)
1200mm (47in.)	1.03cu.m (1.35cu.yd)	705kg (1555lb)
1350mm (53in.)	1.05cu.m (1.37cu.yd)	679kg (1497lb)
1450mm (57in.)	1.14cu.m (1.49cu.yd)	720kg (1588lb)
1500mm (59in.)	1.19cu.m (1.56cu.yd)	734kg (1618lb)

## WEIGHTS AND GROUND BEARING PRESSURES

Figures include 1.14cu.m. bucket (760kg (1675lbs), operator, full fuel tank, 600mm track shoes and 2.4m dipper.

	JS200 Mono NC			
	Machine weight		Ground bearing pressure	
	kg	lbs	kg/cm	lb/sq ft
500mm shoes	19845	43750	0.48	6.80
600mm shoes	20095	44305	0.40	5.69
700mm shoes	20350	44860	0.35	5.00
800mm shoes	–	–	–	–
900mm shoes	–	–	–	–
	JS200 Mono SC			
	kg	lbs	kg/cm	lb/sq ft
	500mm shoes	19925	43930	0.48
600mm shoes	20180	44490	0.40	5.69
700mm shoes	20430	45040	0.35	5.00
800mm shoes	–	–	–	–
900mm shoes	–	–	–	–
	JS200 Mono LC			
	kg	lbs	kg/cm	lb/sq ft
	500mm shoes	–	–	–
600mm shoes	20605	45420	0.38	5.40
700mm shoes	20870	46010	0.33	4.70
800mm shoes	21140	46605	0.30	4.30
900mm shoes	21190	46710	0.26	3.70

## STANDARD / OPTIONAL EQUIPMENT

**Standard Equipment:** Engine fan guard; Cold start pre-heat; Auto engine warm up; Double element air cleaner; Electric refuelling pump; Heavy duty alternator; Electrics isolator; Heavy duty batteries; Cab & engine soundproofing; Cab heater & screen demister; Tinted glass; Radio & cassette player; Interior light; Coat hook; Cigarette lighter; Ashtray; Operator's storage box; Removable floor mat; Windscreen wash/wipe; Plug-in power socket; Automatic power boost; Auto-idle; One-touch engine speed control; Hydraulic cushion control; Boom/swing priority switch; Plexus hydraulic oil filtration; HSP pressure test points; Auxiliary pipework mounting brackets; Work lights – boom & mainframe mounted; Undercarriage belly guarding; Upper structure under covers; Swing system cover; Twin track guides; External mirrors; Handrail & non slip walk ways; Quick connect engine oil drain pipe; Front screen blind; Quick connect fuel tank drain pipe; Hinged engine under cover.

**Optional Equipment:** Hose burst check valves & overload warning system; Tipping link mounted lift points; General purpose buckets; Ditch/grading buckets; Quickhitch buckets; Hydraulic hammers; Auxiliary pipework (full and low flow); Air conditioning or climate control; Cab mounted & rear work lights; Rotating beacon; Rain guard; Biodegradeable oil; Air suspension seat with heated pad and lumbar support adjustment; lower screen wiper.



# JCB TRACKED EXCAVATOR | JS 200 NC/SC/LC



## WORKING RANGE

Boom length 5.70m			1.91m	2.40m	3.00m
Dipper length					
A	Maximum digging reach	m (ft-in)	8.89 (29-2)	9.34 (30-8)	9.87 (32-5)
B	Maximum digging reach (on ground)	m (ft-in)	8.70 (28-7)	9.16 (30-1)	9.70 (31-10)
C	Maximum digging depth	m (ft-in)	5.53 (18-2)	6.02 (19-9)	6.60 (21-8)
D	Maximum digging height	m (ft-in)	8.95 (29-4)	9.20 (30-2)	9.40 (30-10)
E	Maximum dumping height	m (ft-in)	6.31 (20-8)	6.53 (21-5)	6.75 (22-2)
F	Maximum vertical wall cut depth	m (ft-in)	4.90 (16-1)	5.47 (17-11)	6.07 (19-11)
G	Minimum swing radius	m (ft-in)	3.76 (12-4)	3.71 (12-2)	3.60 (11-10)
	Bucket rotation	deg.	183°	183°	183°
	Dipper tearout (ISO 6015)	kgf (lbf)	13450 (29650)	11560 (25485)	9590 (21142)
	Dipper tearout with boost (ISO 6015)	kgf (lbf)	14610 (32210)	12550 (27670)	10410 (22950)
	Bucket tearout (ISO 6015)	kgf (lbf)	14550 (32080)	14550 (32080)	14550 (32080)
	Bucket tearout with boost (ISO 6015)	kgf (lbf)	15800 (34835)	15800 (34835)	15800 (34835)

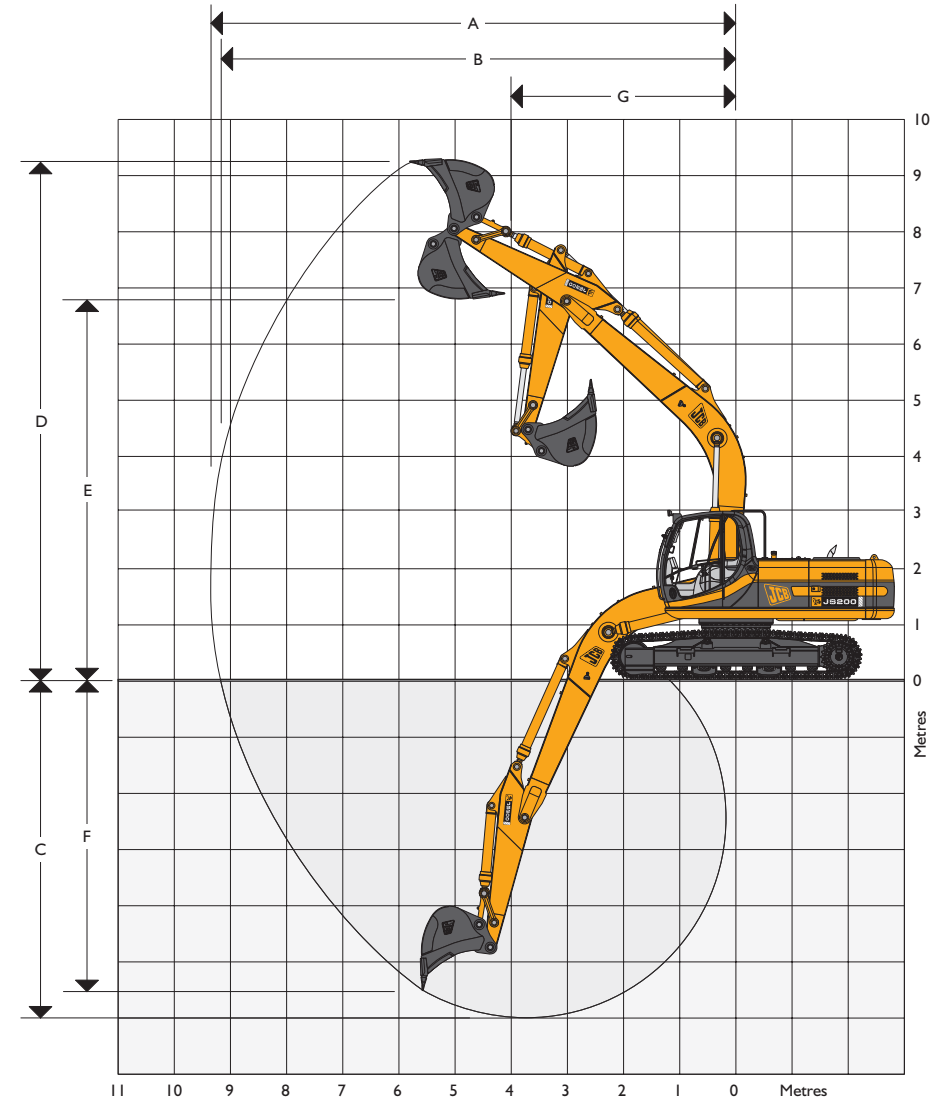













# JCB TRACKED EXCAVATOR | JS 200 NC/SC/LC













## LIFT CAPACITIES – Dipper length: 1.9m, Monoboom: 5.7m, Trackshoes: 500mm, No bucket.



**JS200 NC**

Reach	3m (9ft 10in)		4.5m (14ft 9in)		6m (19ft 8in)		7.5m (24ft 7in)		Max. Reach		Max. Reach
	 kg	 kg	 kg	 kg	 kg	 kg	 kg	 kg	 kg	 kg	
Load Point Ht.	kg	kg	kg	kg	kg	kg	kg	kg	kg	kg	mm
6.0m (19.8ft)					6380*	4040			5720*	3920	6105
4.5m (14.9ft)			8020*	6000	6520	3940			5210	3170	6907
3.0m (9.10ft)			9810	5520	6310	3750			4680	2820	7318
1.5m (4.11ft)			9400	5180	6110	3580			4520	2700	7406
0m			9270	5080	6000	3480			4670	2770	7182
- 1.5m (- 4.11ft)	13010*	9570	9300	5100	6000	3480			5250	3090	6614
- 3.0m (- 9.10ft)	12760*	9740	9460	5240					6780	3930	5596
- 4.5m (- 14.9ft)											

## LIFT CAPACITIES – Dipper length: 2.4m, Monoboom: 5.7m, Trackshoes: 500mm, No bucket.

**JS200 NC**

Reach	3m (9ft 10in)		4.5m (14ft 9in)		6m (19ft 8in)		7.5m (24ft 7in)		Max. Reach		Max. Reach
	 kg	 kg	 kg	 kg	 kg	 kg	 kg	 kg	 kg	 kg	
Load Point Ht.	kg	kg	kg	kg	kg	kg	kg	kg	kg	kg	mm
7.5m (24.7ft)									5230*	4660	5547
6.0m (19.8ft)					5810*	4120			4790*	3370	6767
4.5m (14.9ft)			7330*	6120	6290*	3990			4610	2810	7497
3.0m (9.10ft)			9230*	5650	6350	3790	4540	2740	4210	2540	7878
1.5m (4.11ft)			9500	5260	6140	3600	4440	2660	4080	2440	7959
0m			9290	5090	6000	3480	4380	2600	4190	2490	7751
- 1.5m (- 4.11ft)	10850*	9430	9260	5070	5960	3440			4610	2730	7229
- 3.0m (- 9.10ft)	14090*	9600	9370	5150	6040	3510			5640	3310	6313
- 4.5m (- 14.9ft)			7500*	5410					6850*	5010	4777

-  Lift capacity front and rear.
-  Lift capacity full circle.

- Notes:**
1. For lifting capacity including bucket, subtract total weight of bucket or bucket and quickhitch from above values.
  2. Lifting capacities are based on ISO 10567, that is: 75% of minimum tipping load or 87% of hydraulic lift capacity, whichever is the less. Lifting capacities marked\* are based on hydraulic capacity.
  3. Lift capacities assume that the machine is on firm, level ground.
  4. Lift capacities may be limited by local regulations. Please refer to your dealer.













# JCB TRACKED EXCAVATOR | JS 200 NC/SC/LC



LIFT CAPACITIES – Dipper length: 3.0m, Monoboam: 5.7m, Trackshoes: 500mm, No bucket.

**JS200 NC**

Reach	3m (9ft 10in)		4.5m (14ft 9in)		6m (19ft 8in)		7.5m (24ft 7in)		Max. Reach		Max. Reach
	 kg	 kg	 kg	 kg	 kg	 kg	 kg	 kg	 kg	 kg	
Load Point Ht.	kg	kg	kg	kg	kg	kg	kg	kg	kg	kg	mm
7.5m (24.7ft)					4350*	4220			3440*	3440*	6285
6.0m (19.8ft)					5170*	4210			3210*	2970	7382
4.5m (14.9ft)					5740*	4060	4670	2860	3160*	2530	8056
3.0m (9.10ft)	11580*	10410	8380*	5790	6420	3850	4570	2770	3230*	2310	8411
1.5m (4.11ft)			9610	5340	6170	3630	4450	2660	3430*	2220	8488
0m	6400*	6400*	9300	5090	5990	3470	4360	2570	3790	2250	8293
- 1.5m (- 4.11ft)	10510*	9240	9200	5010	5910	3400	4320	2540	4100	2420	7807
- 3.0m (- 9.10ft)	15320*	9390	9250	5050	5940	3420			4830	2840	6969
- 4.5m (- 14.9ft)	12460*	9690	8920*	5220					6730	3900	5619

 Lift capacity front and rear.

 Lift capacity full circle.

- Notes:**
1. For lifting capacity including bucket, subtract total weight of bucket or bucket and quickhitch from above values.
  2. Lifting capacities are based on ISO 10567, that is: 75% of minimum tipping load or 87% of hydraulic lift capacity, whichever is the less. Lifting capacities marked\* are based on hydraulic capacity.
  3. Lift capacities assume that the machine is on firm, level ground.
  4. Lift capacities may be limited by local regulations. Please refer to your dealer.













# JCB TRACKED EXCAVATOR | JS 200 NC/SC/LC













## LIFT CAPACITIES – Dipper length: 1.9m, Monoboam: 5.7m, Trackshoes: 600mm, No bucket.



**JS200 SC**

Reach	3m (9ft 10in)		4.5m (14ft 9in)		6m (19ft 8in)		7.5m (24ft 7in)		Max. Reach		Max. Reach
	 kg	 kg	 kg	 kg	 kg	 kg	 kg	 kg	 kg	 kg	
Load Point Ht.	kg	kg	kg	kg	kg	kg	kg	kg	kg	kg	mm
6.0m (19.8ft)					6380*	4500			5720*	4370	6105
4.5m (14.9ft)			8020*	6730	6610	4390			5290	3530	6907
3.0m (9.10ft)			9870*	6230	6400	4200			4750	3160	7318
1.5m (4.11ft)			9540	5880	6200	4030			4590	3030	7406
0m			9410	5770	6090	3930			4750	3120	7182
- 1.5m (- 4.11ft)	13010*	11110	9440	5800	6090	3920			5330	3480	6614
- 3.0m (- 9.10ft)	12760*	11290	9610	5940					6880	4430	5596
- 4.5m (- 14.9ft)											

## LIFT CAPACITIES – Dipper length: 2.4m, Monoboam: 5.7m, Trackshoes: 600mm, No bucket.

**JS200 SC**

Reach	3m (9ft 10in)		4.5m (14ft 9in)		6m (19ft 8in)		7.5m (24ft 7in)		Max. Reach		Max. Reach
	 kg	 kg	 kg	 kg	 kg	 kg	 kg	 kg	 kg	 kg	
Load Point Ht.	kg	kg	kg	kg	kg	kg	kg	kg	kg	kg	mm
7.5m (24.7ft)									5230*	5170	5547
6.0m (19.8ft)					5810*	4580			4790*	3750	6767
4.5m (14.9ft)			7330*	6860	6920	4450			4680	3140	7497
3.0m (9.10ft)			9230*	6360	6450	4240	4610	3070	4270	2840	7878
1.5m (4.11ft)			9640	5970	6230	4050	4510	2980	4140	2740	7959
0m			9430	5790	6090	3920	4450	2920	4520	2800	7751
- 1.5m (- 4.11ft)	10850*	10850*	9400	5760	6050	3880			4680	3070	7229
- 3.0m (- 9.10ft)	14090*	11140	9510	5850	6130	3960			5720	3720	6313
- 4.5m (- 14.9ft)			7500*	6120					6850*	5650	4777

-  Lift capacity front and rear.
-  Lift capacity full circle.

- Notes:**
1. For lifting capacity including bucket, subtract total weight of bucket or bucket and quickhitch from above values.
  2. Lifting capacities are based on ISO 10567, that is: 75% of minimum tipping load or 87% of hydraulic lift capacity, whichever is the less. Lifting capacities marked\* are based on hydraulic capacity.
  3. Lift capacities assume that the machine is on firm, level ground.
  4. Lift capacities may be limited by local regulations. Please refer to your dealer.











# JCB TRACKED EXCAVATOR | JS 200 NC/SC/LC



LIFT CAPACITIES – Dipper length: 3.0m, Monoboom: 5.7m, Trackshoes: 600mm, No bucket.

**JS200 SC**

Reach	3m (9ft 10in)		4.5m (14ft 9in)		6m (19ft 8in)		7.5m (24ft 7in)		Max. Reach		Max. Reach
	 kg	 kg	 kg	 kg	 kg	 kg	 kg	 kg	 kg	 kg	
Load Point Ht.	kg	kg	kg	kg	kg	kg	kg	kg	kg	kg	mm
7.5m (24.7ft)					4350*	4350*			3440*	3440*	6285
6.0m (19.8ft)					5170*	4670			3210*	3210*	7382
4.5m (14.9ft)					5740*	4520	4740	3190	3160*	2830	8056
3.0m (9.10ft)	11580*	11580*	8380*	6510	6510	4300	4640	3090	3230*	2580	8411
1.5m (4.11ft)			9750	6050	6270	4070	4520	2980	3430*	2490	8488
0m	6400*	6400*	9440	5790	6090	3910	4430	2900	3800*	2530	8293
- 1.5m (- 4.11ft)	10510*	10510*	9340	5700	6010	3840	4390	2870	4170	2730	7807
- 3.0m (- 9.10ft)	15320*	10920	9390	5750	6030	3860			4910	3200	6969
- 4.5m (- 14.9ft)	12460*	11240	8920*	5930					6760*	4390	5619

 Lift capacity front and rear.

 Lift capacity full circle.

- Notes:**
1. For lifting capacity including bucket, subtract total weight of bucket or bucket and quickhitch from above values.
  2. Lifting capacities are based on ISO 10567, that is: 75% of minimum tipping load or 87% of hydraulic lift capacity, whichever is the less. Lifting capacities marked\* are based on hydraulic capacity.
  3. Lift capacities assume that the machine is on firm, level ground.
  4. Lift capacities may be limited by local regulations. Please refer to your dealer.













# JCB TRACKED EXCAVATOR | JS 200 NC/SC/LC













## LIFT CAPACITIES – Dipper length: 1.9m, Monoboom: 5.7m, Trackshoes: 700mm, No bucket.



**JS200 LC**

Reach	3m (9ft 10in)		4.5m (14ft 9in)		6m (19ft 8in)		7.5m (24ft 7in)		Max. Reach		Max. Reach
	 kg	 kg	 kg	 kg	 kg	 kg	 kg	 kg	 kg	 kg	
Load Point Ht.	kg	kg	kg	kg	kg	kg	kg	kg	kg	kg	mm
6.0m (19.8ft)					6380*	5010			5720*	4870	6105
4.5m (14.9ft)			8020*	7550	6720*	4910			5700*	3950	6907
3.0m (9.10ft)			9870*	7040	7350	4710			5430	3540	7318
1.5m (4.11ft)			11200	6690	7150	4530			5260	3410	7406
0m			11060	6570	7040	4430			5440	3510	7182
- 1.5m (- 4.11ft)	13010*	12910	11040*	6600	7030	4430			6130	3920	6614
- 3.0m (- 9.10ft)	12760*	12760*	9650	6740					7600*	4990	5596
- 4.5m (- 14.9ft)											

## LIFT CAPACITIES – Dipper length: 2.4m, Monoboom: 5.7m, Trackshoes: 700mm, No bucket.

**JS200 LC**

Reach	3m (9ft 10in)		4.5m (14ft 9in)		6m (19ft 8in)		7.5m (24ft 7in)		Max. Reach		Max. Reach
	 kg	 kg	 kg	 kg	 kg	 kg	 kg	 kg	 kg	 kg	
Load Point Ht.	kg	kg	kg	kg	kg	kg	kg	kg	kg	kg	mm
7.5m (24.7ft)									5230*	5230*	5547
6.0m (19.8ft)					5810*	5100			4790*	4180	6767
4.5m (14.9ft)			7330*	7330*	6290*	4970			4690	3510	7497
3.0m (9.10ft)			9230*	7180	7110*	4760	5260	3440	4800*	3190	7878
1.5m (4.11ft)			10820*	6770	7180	4560	5160	3350	4740	3080	7959
0m			11080	6590	7030	4430	5100	3290	4870	3150	7751
- 1.5m (- 4.11ft)	10850*	10850*	11050	6560	6990	4390			5370	3460	7229
- 3.0m (- 9.10ft)	14090*	12940	10270*	6650	7070	4470			6590	4190	6313
- 4.5m (- 14.9ft)			7500*	6930					6850*	6380	4777

-  Lift capacity front and rear.
-  Lift capacity full circle.

- Notes:**
1. For lifting capacity including bucket, subtract total weight of bucket or bucket and quickhitch from above values.
  2. Lifting capacities are based on ISO 10567, that is: 75% of minimum tipping load or 87% of hydraulic lift capacity, whichever is the less. Lifting capacities marked\* are based on hydraulic capacity.
  3. Lift capacities assume that the machine is on firm, level ground.
  4. Lift capacities may be limited by local regulations. Please refer to your dealer.













# JCB TRACKED EXCAVATOR | JS 200 NC/SC/LC



LIFT CAPACITIES – Dipper length: 3.0m, Monoboom: 5.7m, Trackshoes: 700mm, No bucket.

**JS200 LC**

Reach	3m (9ft 10in)		4.5m (14ft 9in)		6m (19ft 8in)		7.5m (24ft 7in)		Max. Reach		Max. Reach
	 kg	 kg	 kg	 kg	 kg	 kg	 kg	 kg	 kg	 kg	
Load Point Ht.	kg	kg	kg	kg	kg	kg	kg	kg	kg	kg	mm
7.5m (24.7ft)					4350*	4350*			3440*	3440*	6285
6.0m (19.8ft)					5170*	5170*			3210*	3210*	7382
4.5m (14.9ft)					5740*	5040	5190*	3560	3160*	3160*	8056
3.0m (9.10ft)	11580*	11580*	8380*	7340	6630*	4810	5290	3470	3230*	2900	8411
1.5m (4.11ft)			10200*	6860	7220	4590	5170	3350	3430*	2800	8488
0m	6400*	6400*	11100	6590	7030	4420	5080	3270	3800*	2850	8293
- 1.5m (- 4.11ft)	10510*	10510*	10990	6500	6950	4350	5040	3240	4470*	3080	7807
- 3.0m (- 9.10ft)	15320*	12710	10770*	6550	6970	4370			5640	3610	6969
- 4.5m (- 14.9ft)	12460*	12460*	8920*	6730					6760*	4950	5619

 Lift capacity front and rear.

 Lift capacity full circle.

- Notes:**
1. For lifting capacity including bucket, subtract total weight of bucket or bucket and quickhitch from above values.
  2. Lifting capacities are based on ISO 10567, that is: 75% of minimum tipping load or 87% of hydraulic lift capacity, whichever is the less. Lifting capacities marked\* are based on hydraulic capacity.
  3. Lift capacities assume that the machine is on firm, level ground.
  4. Lift capacities may be limited by local regulations. Please refer to your dealer.



## A GLOBAL COMMITMENT TO QUALITY

JCB's total commitment to its products and customers has helped it grow from a one-man business into Britain's largest privately owned manufacturer of backhoe loaders, crawler excavators, wheeled excavators, telescopic handlers, wheeled loaders, dump trucks, rough terrain fork lifts, industrial fork lifts, mini/midi excavators, skid steer loaders and tractors.

By making constant and massive investments in the latest production technology, the JCB factories have become some of the most advanced in Europe.

By leading the field in innovative research and design, extensive testing and stringent quality control, JCB machines have become renowned all over the world for performance, value and reliability.

And with a global sales and service network of over 400 distributors and agents, the company exports over 70% of its production to all five continents.

Through setting the standards by which others are judged, JCB has become one of Britain's most impressive success stories.

